

# Screenless Slow Speed Beside-the-Press Recycling

Compact S Series Granulators are ideally suited for metered robot or conveyor feed beside small injection molding machines.

This quiet, energy efficient granulator features a screenless cutter housing and ultra-low rotor speed to reduce sprues and runners to consistently sized granules, virtually free of fines and longs.



Model S912

## Ultra-Low RPM for Clean Regrind

The S Series screenless granulators turn sprues and runners into extremely uniform granulate with low energy consumption and very little noise.

Available in three sizes for throughputs of up to 40 lb/hr, the S Series granulators are built around a single, low-speed rotor. As the rotor turns, large crusher blades slide through blind slots in the cutting chamber, breaking up scrap parts/runners into smaller pieces that are further reduced by a series of cutters machined into the rotor. These cutters pass through stationary combs to produce properly sized regrind fall into a catch bin. No screen is needed.

The resulting regrind is uniform in size and contains very little dust or fines, so it can be metered evenly back into the process providing consistent melt homogeneity for higher-quality molding.

### ▶ Multi-tooth rotor

Multi-tooth rotor cleanly reduces sprues and runners to consistent sized particles. Rotors with D2 teeth and cutting wheels can be re-sharpened. The automatic reversing option helps to clear obstructed material.

### ▶ Easy portability

Large casters allow easy movement; the S Series conveniently services multiple presses. The small footprint accommodates tight spaces and the wide-mouth, flared in-feed hopper easily handles a range of robot or conveyor drops and sprue/runner sizes.

### ▶ Quiet operation

The S Series low-speed rotor decreases noise levels with most materials to as low as 80 dbA and in some cases as low as 70 dbA, eliminating the need for sound enclosures.

### ▶ No tools access

Hand knobs for the hopper and bin provide fast convenient access to the rotor and swing-open cutter housing cover. Thorough clean out and material changeover is easily accomplished in minutes.

### ▶ Reduce machine wear; preserve material

When the automatic reversing option is included, the granulator will reverse rotor rotation up to three times to clear any thick material from the cutting circle before automatically shutting down. This option eliminates potential damage to your granulator and cutting blades.



# Feeding/Evacuation Configurations

## Hand Feeding

The standard, clear feed hopper allows easy dropping of scrap into the granulator by hand. Safe, low speed/ low noise operation means the S Series can be located near personnel with no concerns.

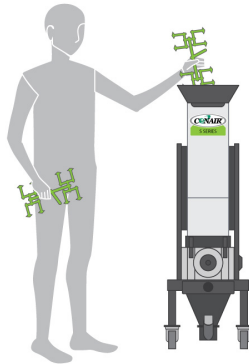

## Robot Feeding

The tall, open top feed hopper includes a bolt on funnel that provides a large target for robotic scrap feeding. The clear hopper visually confirms that scrap is freely moving through the granulator.

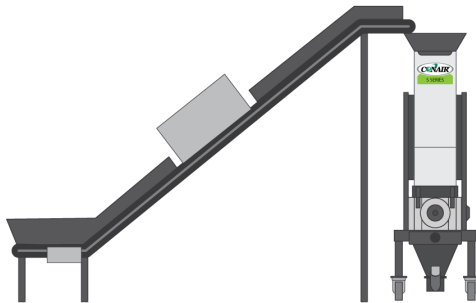

## Conveyor Feeding

Optimized, meter feeding of scrap by a compact, speed-controlled conveyor. Conveyor can include a metal detector that stops conveying when metal in the scrap is detected. An optional metal detection system in the S Series can also detect tramp metal and stop the granulator.

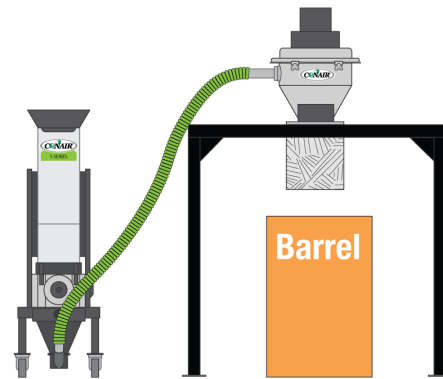

## Vacuum Take-off Evacuation

A vacuum pick-up tube is used to pull granulate from its compact drawer. Multiple types of loaders/receivers can be used, programmed to convey by a sensor in the granulator drawer or special loading control settings.

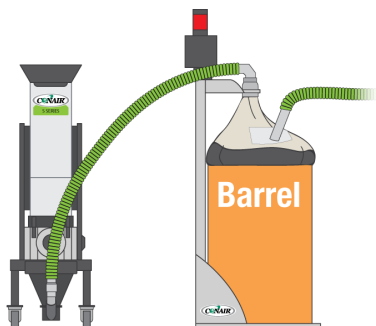

## Compressed Air to EVB Evacuation

A pick-up tube with venturi is used to pull granulate from the granulator drawer and push it into a barrel. Conair's CAML-EVB compressed air evacuation system can be set to move granulate on a timed basis, or with a demand sensor.

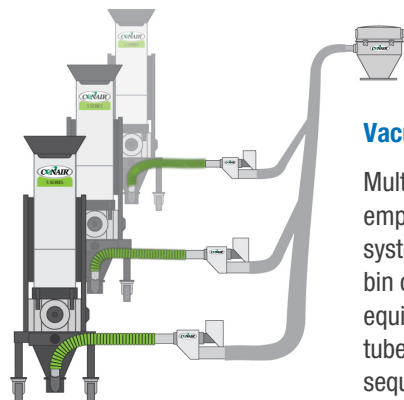

## Vacuum System Evacuation

Multiple granulators can be emptied by a central vacuum system to a common collection bin or box. Each granulator is equipped with a vacuum pick-up tube and a material line valve, sequenced by the central loading control (e.g. Conair FLX-128).



# Specifications

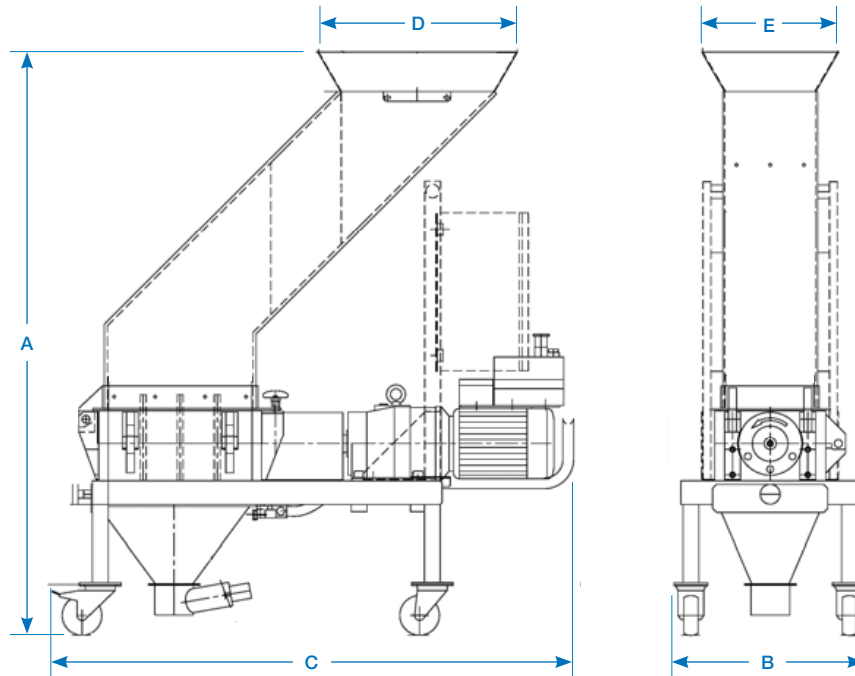

Models	S97	S910	S914	S918
<b>Performance characteristics</b>				
Maximum throughput* lb/hr {kg/hr}	up to 9 {4}	up to 20 {9}	up to 30 {14}	up to 40 {18}
Cutting chamber opening inches {mm}	9 x 6.8 {228 x 173}	9 x 10.4 {228 x 265}	9 x 14.1 {228 x 359}	9 x 17.8 {228 x 453}
Rotor speed rpm	28			
Motor power Hp {kW}	3 {2.2}			
Cutter size inches {mm}	5 {127}			
<b>Dimensions inches {mm}</b>				
A - Height	50.6 {1284}	52.1 {1,325}	58.0 {1,473}	57.7 {1,466}
B - Width	24.2 {615}	19.0 {485}		
C - Overall depth	30.8 {782}	50.2 {1,276}	54.0 {1,370}	57.6 {1,466}
D - Hopper opening width	13.6 {345}	17.6 {448}	19.8 {502}	27.0 {691}
E - Hopper opening depth	13.5 {342}			

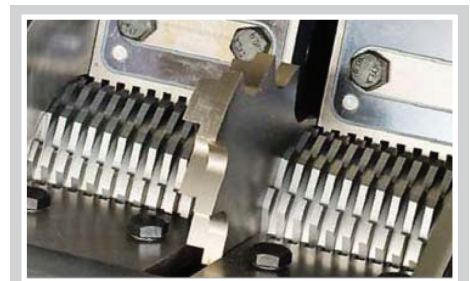

Cutter wheel (multi-toothed) and large crusher blades.

## Options

- Integrated metal detection protects machine from damage or metal contamination
- Automatic reversing system is available for reversing the rotation of the rotor to easily clear any material obstruction

### Specification Notes

\* Throughputs are provided as a capacity guideline only. Throughput will be greater or lesser than the values shown according to the shape, size, thickness and properties of the material to be cut.  
 Consult Conair for a material test or help determining the correct granulator model for your application.  
 Specifications may change without notice. Check with a Conair representative for the most current information

## Features

- Infeed hopper specifically designed for beside-the-press manual or robot-fed loading
- No sizing screen (screenless)
- Clear-view hopper design allows the operator to see the material being processed
- Emergency stop button
- Energy saving low horsepower
- Uniform granule size
- Heavy-duty construction
- No special tools are required to open the granulator
- D2 crusher blades and cutting wheels
- Re-sharpenable blades and cutting wheels
- Quiet operation (70 to 80 dB)
- Multiple safety interlocks prevent injury by restricting access to the granulator while operating
- Compact and mobile, caster mounted base saves valuable floor space and provides greater versatility



